

4 x screw connection:  
 1 x hexagon head bolt  
 DIN 933-M16x55-A2  
 2 x washer DIN 125-Ø17-A2  
 1 x cap nut DIN 986-M16-A2

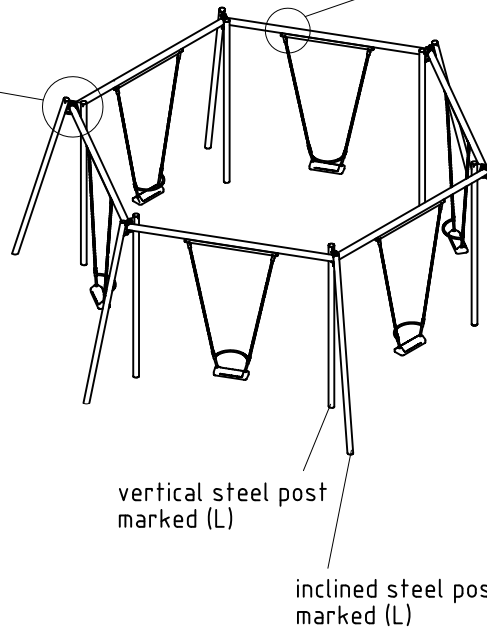

vertical steel post  
 marked (L)

inclined steel post  
 marked (L)

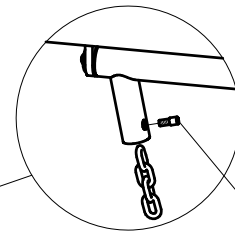

cheese-head screw  
 DIN 912/ISO 4762-  
 M8x20-A2

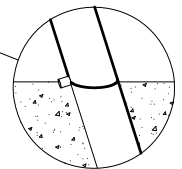

Playlevel mark  
 (= pin) conforms  
 to the mounting  
 depth of steel  
 post

1. Assign location of equipment considering the minimum space requirement (impact area).
2. Excavate soil for foundations, according to drawing.  
 Please note: To achieve maximum stability and a safe installation, a moderate level of soil solubility is required.
3. **Attention: For installation of the posts at swing crossbeam the screws slightly have to be lubricated with installation paste!**
4. Mount steel posts at crossbeam according to drawing.  
 (use 1 inclined post and 1 vertical post per swing crossbeam)
5. Put assembled equipment into foundation holes and align it.
6. Grout foundations with compressed concrete C20/25, chamfer and round off the edges and cover with a surface which meets the requirements for impact attenuation so that the critical height of the surfacing shall be equal to or greater than the free height of fall (acc. to EN 1176-1).
7. After concrete foundations have set, attach chains to chain adapter in swing axle: Unscrew cheese head screw (M8x20) inside adapter, insert last chain link and fix with screw. Please note that the cheese-head screw stoutly has to be tightened e.g. with Allen key or catch without overwinding.  
 If necessary, cut length of chain in order to ensure minimum ground clearance of 0.45 m.
8. According to maintenance instructions, check all screw connections after 4-5 weeks and retighten, if necessary.

Please take care that all special tools (e.g. special Allen key for secured Allen screws etc.) and all specific documents which are or may be useful for safety management acc. to EN 1176-7 (e.g. invoice, delivery note, order acknowledgement, installation instructions, maintenance instructions) are forwarded to the responsible persons.

minimum space requirement:

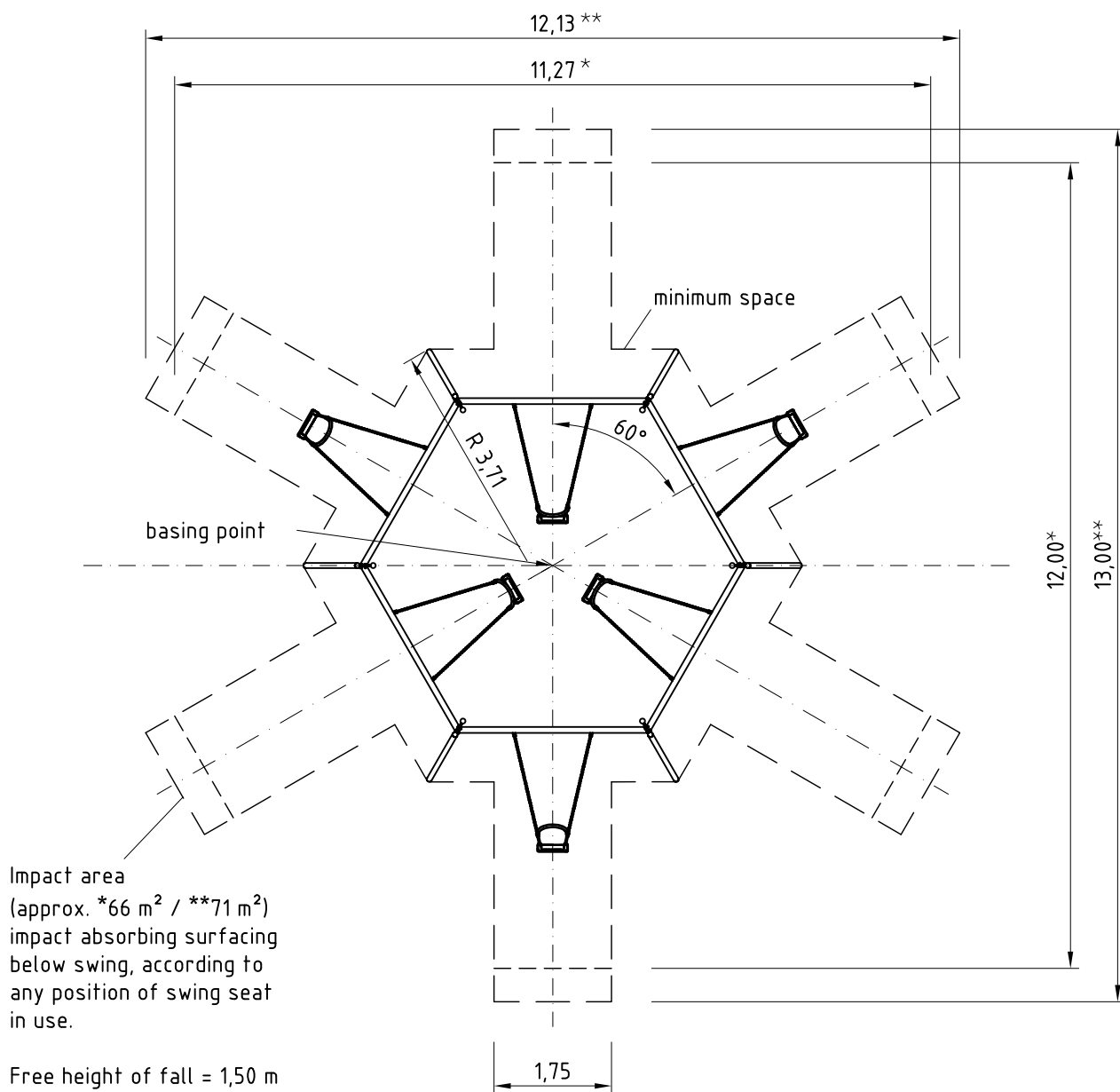

- \* measure in case of synthetic surfacing with impact absorbing effect that is level with the surrounding area (cf. EN 1176-2 / 4.10.2.1).
- \*\* measure in case of natural surfacing with impact absorbing effect (cf. EN 1176-2 / 4.10.2.1).

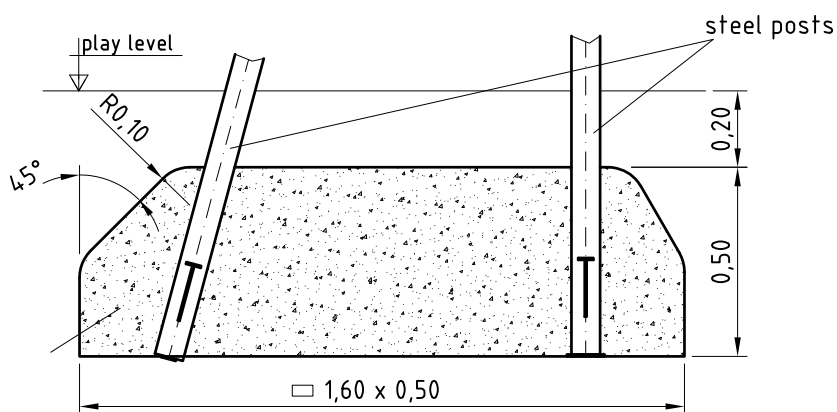
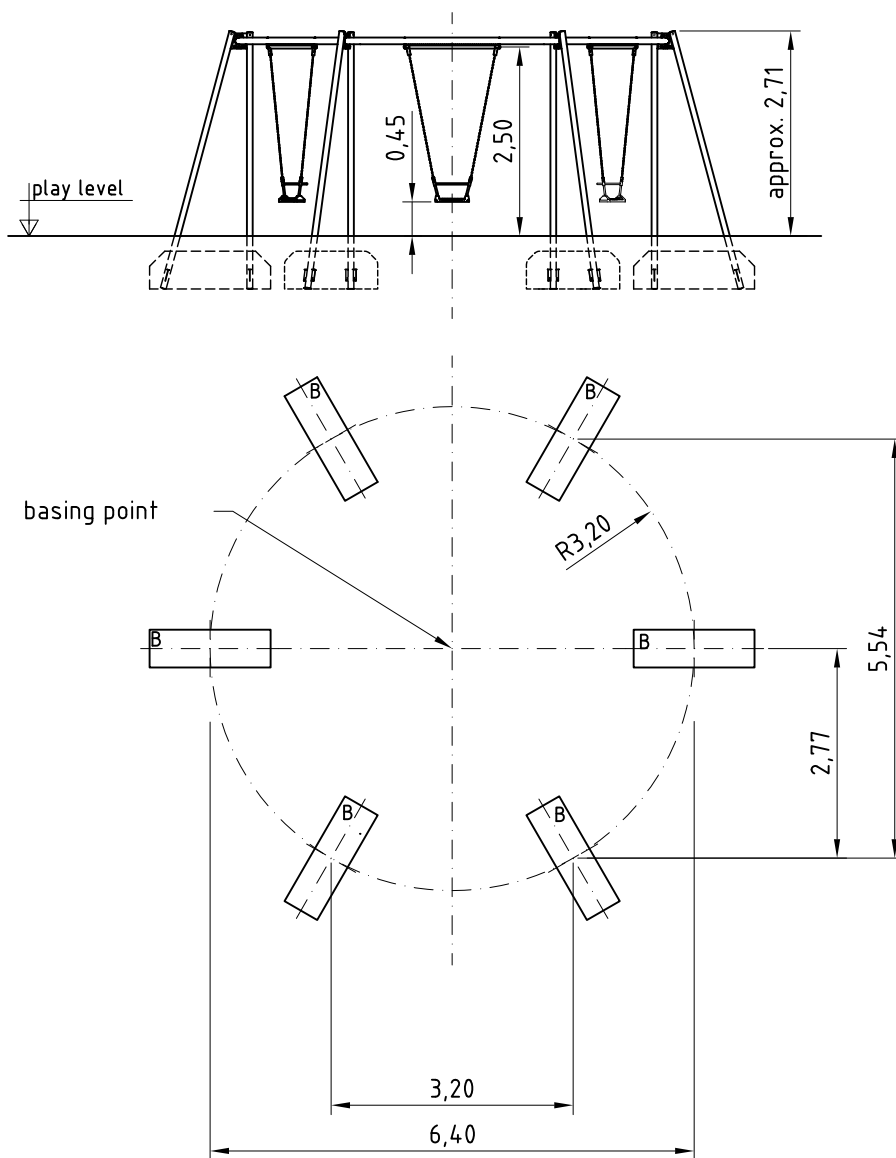





\* measure in case of synthetic surfacing with impact absorbing effect that is level with the surrounding area (cf. EN 1176-2 / 4.10.2.1).

\*\* measure in case of natural surfacing with impact absorbing effect (cf. EN 1176-2 / 4.10.2.1).

# Installation

Article No. Description  
 0-40556-000 K&K standard contact swing (2,50)  
 0-40566-000

Scale Date Page  
 1:100 05/12 EB 3/3

<u>Parts list</u>		040566000	GB
item no.	quantity	description	image
1060603	6	Mounted middle crossbeam for contact swings A2	
1060607	6	Inclined stainless steel contact swing post (2,50)	
1060606	6	Vertical stainless steel contact swing post (2,50)	
1060122	6	Black contact swing suspension set 2,50 m	
1296795	1	Fastening kit for K&K Contact swings	