

1. Assign a device location considering the minimum space requirements (impact area).
2. Excavate soil for foundations, according to drawing.
Please note: To achieve maximum stability and safe installation, a moderate level of soil solubility is required.
- 3. Before fastening the posts to the swing crossbeam, slightly lubricate the screws with installation paste!**
4. Due to the danger of overstraining the tube bends of the posts, we recommend to begin with mounting only two posts to the crossbeam, according to drawing. Raise the unit by using an appropriate lifting gear (e.g. small crane) and put assembly into foundation holes. Support temporarily, in accordance with all security-relevant rules.
5. Afterwards mount the remaining two posts to the crossbeam, align item horizontally considering the play level marks for installation depth.
6. Grout foundations with compressed concrete C20/25, chamfer and round off the edges and cover with a surface which meets the requirements for impact attenuation so that the critical fall height of the surfacing is equal to, or greater than, the free height of fall of the equipment (acc. to EN 1176-1).
7. After concrete foundations have set, attach chains to chain adapters in swing axle: unscrew cheese head screw (M8x20-A2) inside adapter, insert the last chain link and fix it with the screw. Attention: the cheese-head screw slightly has to be lubricated with installation paste! Please note that the cheese-head screw has to be hand tightened e.g. with an Allen key or a catch without overwinding.
If necessary, shorten length of chain in order to ensure ground clearance of at least 0,60 m below swing seat.
8. Check all screw connections according to maintenance instructions after 4-5 weeks and retighten, if necessary.

Please ensure that all special tools supplied (e.g. Allen key for secured Allen screws etc.) and all specific documents which are or may be useful for safety management acc. to EN 1176-7 (e.g. invoice, delivery note, order acknowledgement, installation instructions, maintenance instructions) are forwarded to the persons responsible.

impact area
(approx. * 36 m² resp. ** 40m²).
Area to be covered by impact
absorbing surfacing under each
swing position

minimum space:

free height of fall = 2,60

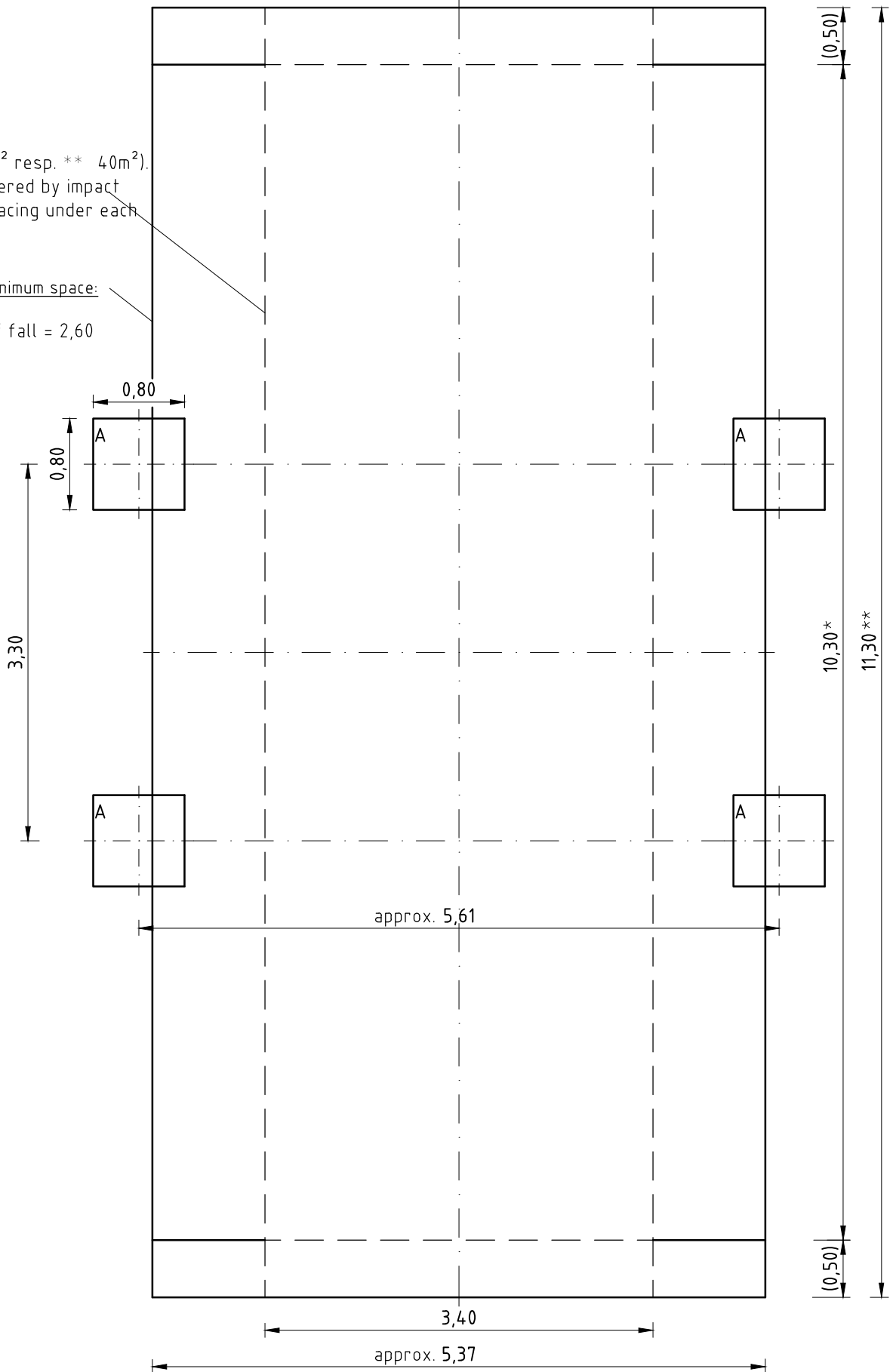

*) measure for synthetic surfacing with impact absorbing effect, level with the surrounding area (cf. EN 1176-2:2008 § 4.10.2.1). Within swinging direction, an additional flush area of 0,50m length free from obstacles must be provided

***) measure for natural surfacing with impact absorbing effect, normally loose fill (cf. EN 1176-2:2008 § 4.10.2.1)

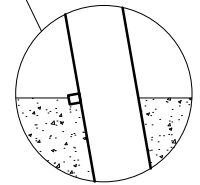
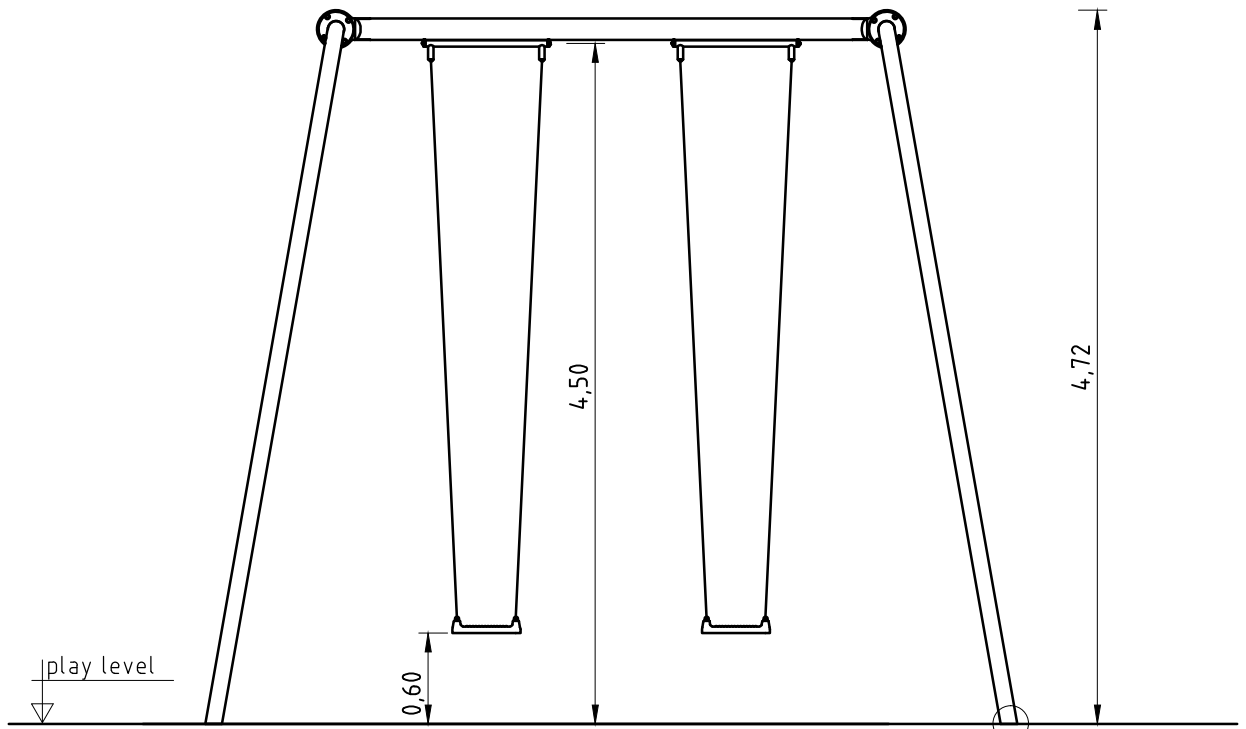

play level mark (= pin) conforms to the mounting depth of steel post

type A
1:20

